



**Motion Control Engineering, Inc.
11380 White Rock Road
Rancho Cordova, CA 95742**

voice 916 463 9200
fax 916 463 9201
www.mceinc.com

**User Guide,
SmarTraq Limitless Door Operator
with Revision 6 Drive**

Copyright

Copyright 2006, Motion Control Engineering. All Rights Reserved.

This document may not be reproduced, electronically or mechanically, in whole or in part, without written permission from Motion Control Engineering.

Trademarks

All trademarks or registered product names appearing in this document are the exclusive property of the respective owners.

Warning and Disclaimer

Although every effort has been made to make this document as complete and accurate as possible, Motion Control Engineering and the document authors, publishers, distributors, and representatives have neither liability nor responsibility for any loss or damage arising from information contained in this document or from informational errors or omissions. Information contained in this document shall not be deemed to constitute a commitment to provide service, equipment, or software by Motion Control Engineering or the document authors, publishers, distributors, or representatives.

Limited Warranty

Motion Control Engineering (manufacturer) warrants its products for a period of 15 months from the date of shipment from its factory to be free from defects in workmanship and materials. Any defect appearing more than 15 months from the date of shipment from the factory shall be deemed to be due to ordinary wear and tear. Manufacturer, however, assumes no risk or liability for results of the use of the products purchased from it, including, but without limiting the generality of the forgoing: (1) The use in combination with any electrical or electronic components, circuits, systems, assemblies or any other material or equipment (2) Unsuitability of this product for use in any circuit, assembly or environment. Purchasers' rights under this warranty shall consist solely of requiring the manufacturer to repair, or in manufacturer's sole discretion, replace free of charge, F.O.B. factory, any defective items received at said factory within the said 15 months and determined by manufacturer to be defective. The giving of or failure to give any advice or recommendation by manufacturer shall not constitute any warranty by or impose any liability upon the manufacturer. This warranty constitutes the sole and exclusive remedy of the purchaser and the exclusive liability of the manufacturer, AND IN LIEU OF ANY AND ALL OTHER WARRANTIES, EXPRESSED, IMPLIED, OR STATUTORY AS TO MERCHANTABILITY, FITNESS, FOR PURPOSE SOLD, DESCRIPTION, QUALITY PRODUCTIVENESS OR ANY OTHER MATTER. In no event will the manufacturer be liable for special or consequential damages or for delay in performance of this warranty.

Products that are not manufactured by MCE (such as drives, CRT's, modems, printers, etc.) are not covered under the above warranty terms. MCE, however, extends the same warranty terms that the original manufacturer of such equipment provide with their product (refer to the warranty terms for such products in their respective manual).

Important Precautions and Useful Information

This preface contains information that will help you understand and safely maintain MCE equipment. We strongly recommend you review this preface and read this manual before installing, adjusting, or maintaining Motion Control Engineering equipment. This preface discusses:

- Safety and Other Symbol Meanings
- Environmental Considerations
- In This Guide

SmarTRAQ™ Drive Warranty will be void if:  WARNING	<ul style="list-style-type: none">→ Drive is damaged by drill shavings, wire strands, or other debris.→ Do NOT apply power if there is metal debris in the Drive!→ Voltage or Ground is applied to TB-5 terminals.→ Do NOT apply voltage or ground! Use DRY RELAY CONTACTS ONLY.→ Damaged/Inoperable Drive is not returned as a complete unit.→ Do NOT attempt to replace printed circuit boards!
--	--

Safety and Other Symbol Meanings



Danger

This manual symbol is used to alert you to procedures, instructions, or situations which, if not done properly, might result in personal injury or substantial equipment damage.



Caution

This manual symbol is used to alert you to procedures, instructions, or situations which, if not done properly, might result in equipment damage.



Note

This manual symbol is used to alert you to instructions or other immediately helpful information.

Environmental Considerations

- Keep ambient temperature between 32 and 104 degrees F (0 to 40 degrees C).
- Prevent condensation on the equipment.
- Make certain that power line fluctuations are within plus or minus 5% of proper value.

In This Guide:

This guide is the installation, adjustment, and troubleshooting guide for SmarTraQ. When viewed online as a pdf file, hyperlinks link to related topics and informational websites. The manual includes:

- [Contents](#): Table of Contents. When viewed online as a pdf file, hyperlinks in the Contents link to the associated topic in the body of the manual.
- [SmarTraQ](#): Product Description, installation, and troubleshooting instructions.

SmarTraq Contents

About SmarTraq	1
Replacement Motors	2
Installation Checklist	4
Installation	5
Cable Access	7
Control Input Wiring and Verification	8
Product Specifications	10
SmarTraq Adjustments	11
Checking Motor Rotation	11
SmarTraq Programmer Controls	12
Learning Full Open and Full Close Positions	13
Establishing DCL	13
Performing the Learn Operation	14
Verifying Door Operation	15
Door Operation Example	15
Adjusting Parameters	16
Parameter Adjustment Example	18
Measuring Door Closing Force	19
Door Closing Time Compliance	19
Troubleshooting	24
Helpful Hints	24
Door Open and Door Close Logic	24
Self-Holding	24
Door Close Limit and Door Open Limit	24
Limit #1 and Limit #2	25
Car Door Bumpers	25
Belt and Chain Tension	25
Motor Terminal Designation	26
Learn Operation	26
Stall Protection	26
Door Open and Door Close Protection Timers	26
Temporary Operation for Evaluation	26
Encoder Cable	27
Auto Reset	27
Control Signal Status	27
Functional Troubleshooting	28
Power Up	28
Motor Synchronization	29
First Door Closing	29
Learn Process	30
First Open/Close After Cycling Power	32
Opening and Closing	33
Reopening and Reclosing	34
Torque Adjustment	35
Maintenance	36
Harmonic Operators	36
Linear Operators	36
Firmware Upgrades	37
Replacing Microchips	38
Board Set Replacement	39

List of Figures

Figure 1. SmarTraq	1
Figure 2. Motor Configurations	3
Figure 3. SmarTraq Wiring Diagram	6
Figure 4. SmarTraq Circuit Boards	7
Figure 5. Verifying Contact States at J6 Door Control Inputs	8
Figure 6. Typical SmarTraq Harmonic Operator	9
Figure 7. Inverter Drive Programmer Switches	11
Figure 8. Motion Profile	16

List of Tables

Table 1. SmarTraq Specifications, Interface Data, and Code Compliance	9
Table 2. Motor Connections from Wiring Diagram	10
Table 3. Motor Connections if Rotation is Counter-Clockwise as Doors Close	10
Table 4. Inverter Drive Parameters	14
Table 5. Center Parting Doors	18
Table 6. Center Parting Doors without Reopening Device (Nudging)	19
Table 7. Side Slide Doors	20
Table 8. Side Slide Doors without Re-Opening (Nudging) Device	21



Quick Topics

- About *SmarTraq*
- Installation Checklist
- Installation
- Product Specifications
- Adjustment
- Measuring Closing Force
- Troubleshooting
- Maintenance
- Firmware Upgrades
- Board Set Replacement



SmarTraq



About *SmarTraq*

SmarTraq is available as an Upgrade Kit or as a Complete Operator:

- Upgrade Kit: Contains a door operator motor that is a bolt-for-bolt replacement for the original motor and a new control unit.
- Complete Operator: Complete operator chassis with motor and control unit. Track, door hangers, door and hoistway hardware and switches as ordered. Harmonic (as shown below) or Linear operators are available.

Figure 1. *SmarTraq*

Upgrade Kit



Complete Harmonic Operator

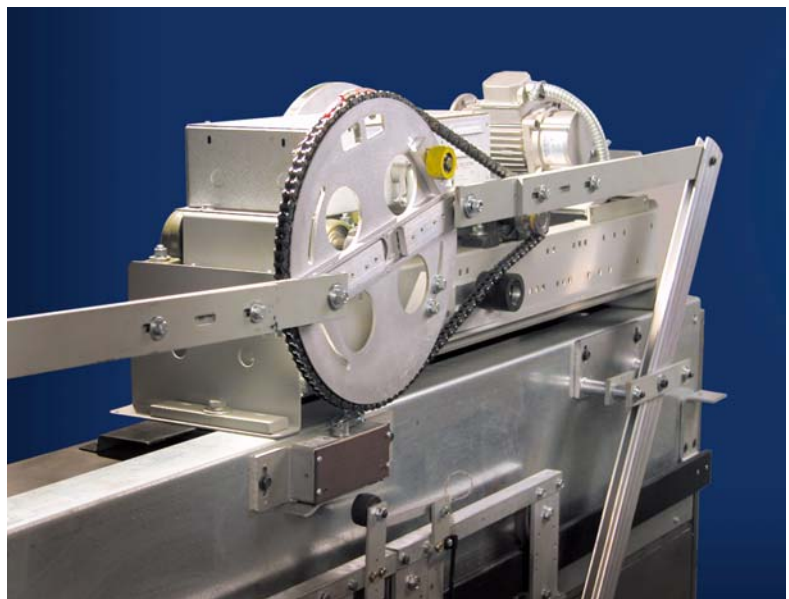

This user guide provides installation, adjustment, and troubleshooting information for the SmarTraq motor and inverter drive. If you ordered a complete door operator package, additional instructions are also provided:

- 42-IS-0103: Harmonic door operator installation instruction
- 42-IS-0107: Linear door operator installation instruction

Replacement Motors

SmarTraq motors are available to replace:

- MCE
 - Center-Parting Door Operator Package
 - Two-Speed Center-Parting Door Operator Package
 - Single-Speed Side Slide Door Operator Package
 - Two-Speed Side Slide Door Operator Package
- Westinghouse
 - Model A Series
 - Model B Series
 - Model BB2
 - Model E Series
 - Model EZ
 - Model HY
 - Model MG
- Haughton
 - T
 - T1
 - TH
- Montgomery
 - MAC Series
- Dover
 - DC Series
 - HD Series
- Otis
 - 6970
 - 7300
 - 7782
- GAL
 - All Models
- Armor
 - C4

Figure 2. Motor Configurations

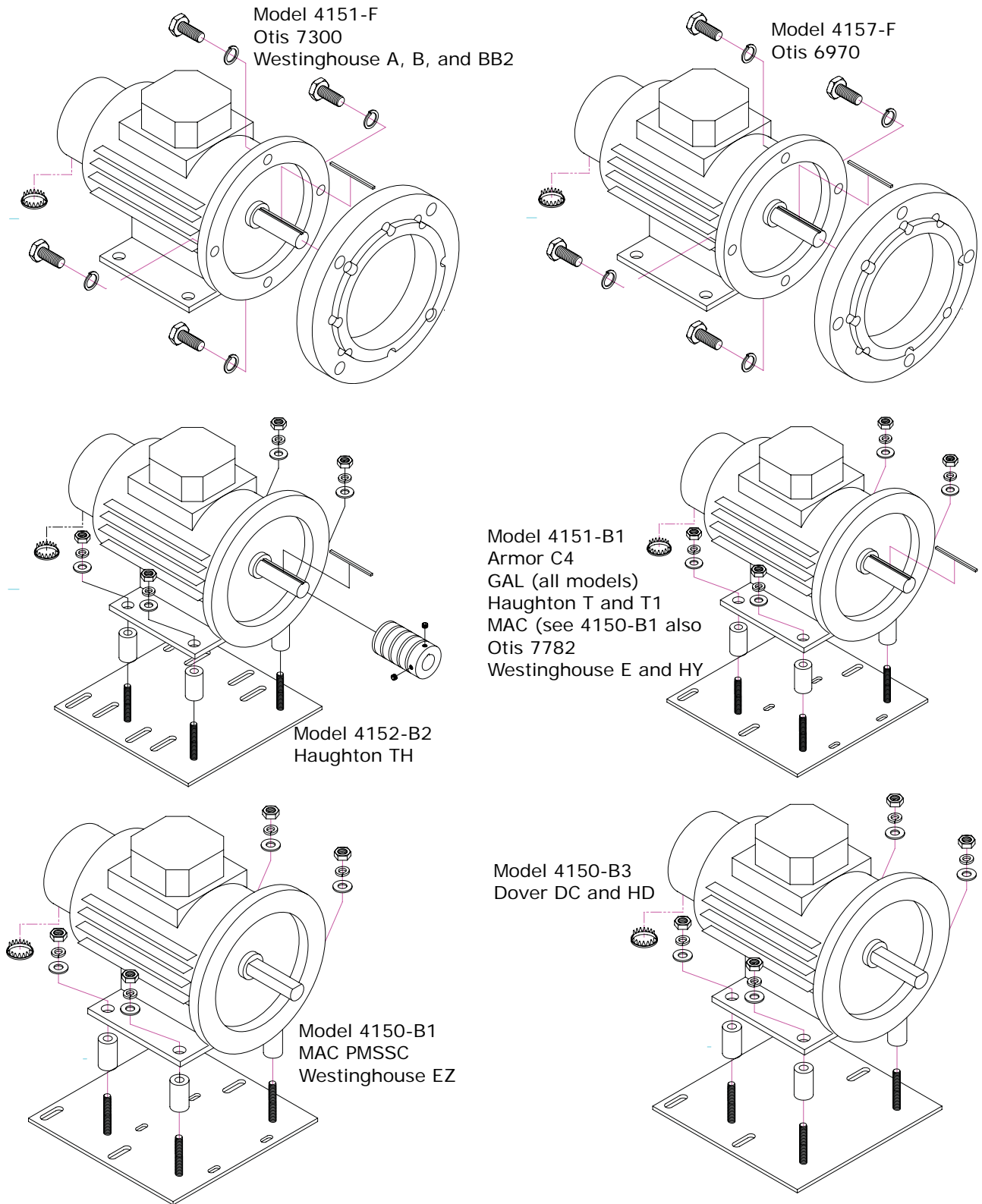

Installation Checklist

Before installing, make sure you have what you need:

1. A fused 120, 208, or 240VAC, single-phase, 350VA minimum, supply available from the elevator controller to the door operator. Input voltage must be within +/- 5% of specified voltage. (DO NOT use the car lighting circuit for door power.)
2. A sufficient number of wires from the controller to the door operator drive:
 - Two wires for power
 - Three wires (one each) for drive common (different from controller common), door open, and door close. One additional wire if nudging is required. One additional wire if heavy door is required. (Three to five wires.)
 - Three wires (one each) for controller common (different from drive common), DCL, and DOL. If DCL and DOL do not share a common wire, then four wires are required. (Three to four wires.)
 - Three or four wires (one each) for auxiliary Limit #1 and Limit #2 for retiring cam, limited door reversal, advance start, etc. are required (depending upon how these limits are wired on your job).



Note

If compliance to ASME A17.1-1996 (Rule 1210.15), ASME A17.1-2000/CSA B44-00 (requirement 2.28.5) or CSA B44-94 (requirement 3.12.1.5) is required, a mechanical Door Position Monitoring Switch must be provided. An MCE switch kit is available, PN# 11-24-0034.

3. Dry (unused), normally open contacts for door open and door close and/or nudging and heavy door (position contact). (If not, can the required contacts be made available by reusing existing contacts for the original door operator or will relays need to be installed in the Controller or on the car?)
4. If installing an Upgrade Kit, all belts, cables, hanger rollers, gibs, clutches, linkages, bearings, and related door operator equipment must be in good condition.
5. If installing a complete door operator, any door operator equipment being retained must be in good condition.
6. All door operators require door open and door close bumpers. Bumpers must be in good condition for proper operation. MCE supplies bumpers for GAL and MAC Door Operators with the upgrade kits. Most other operators already have open and close bumpers.
7. Read this User Guide before starting installation, especially the SmarTraq Adjustments and Troubleshooting sections.

Installation

1. Remove existing motor (upgrade kit installations only). (Remember, only the SmarTraq inverter drive may be used with a SmarTraq motor.)
2. If the car door gate switch is part of the existing limit switch box, leave it in place. Otherwise, limit switches are not required.
3. Install the new motor.

Note

All door operators must have FULL OPEN and FULL CLOSE bumpers.



Caution

Otis 6970 Door Operators: When removing the Otis motor, access to the lower bolt is through the inspection cover on the front of the gear case:

- Remove the inspection cover.
- Rotate the gear so one of the large holes exposes the lower bolt.
- Be careful not to drop the bolt or the lock washer in the gear case.
- Oil checks need to be adjusted for minimal effect. However, do not completely back out existing oil check adjustments.

4. Unless the existing belt is in like-new condition, replace it with a robust, grip-type belt with notches.
5. Adjust belt tension. (Closed-loop control requires minimal belt elasticity, slack, or slippage.)
6. Adjust all chains and cables for minimal slack.
7. Mount the inverter drive enclosure in a location that allows the provided 8-foot (2.5 meter) encoder cable to easily reach from the motor to the enclosure. (Coil any excess cable length inside the drive enclosure. Avoid trimming the encoder cable.)

Note

If the encoder cable is trimmed, an unused brown wire will be exposed. Do not use the brown wire. Note that the original yellow/green wire was soldered to the cable shield. If removed, it must be replaced and connected as shown in the wiring diagram.

8. Check that the drive On/Off switch is set to OFF. Connect the encoder cable and power wires from the motor to the drive as shown in the wiring diagram.
9. Make connections between the drive and the elevator controller as shown in the wiring diagram.
10. The drive is factory- configured for 120VAC power. To configure for 208 or 240VAC power, move the input select wire. [Please refer to “SmarTraq Wiring Diagram” on page 6](#) and information on [page 9](#). Refer to the controller job prints for other wiring.

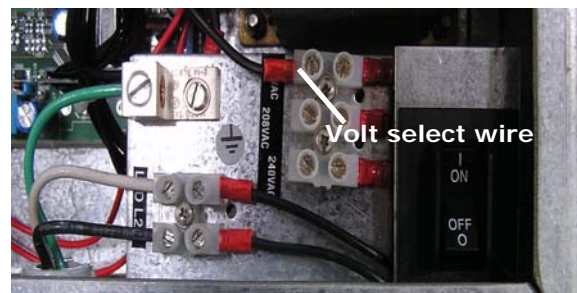
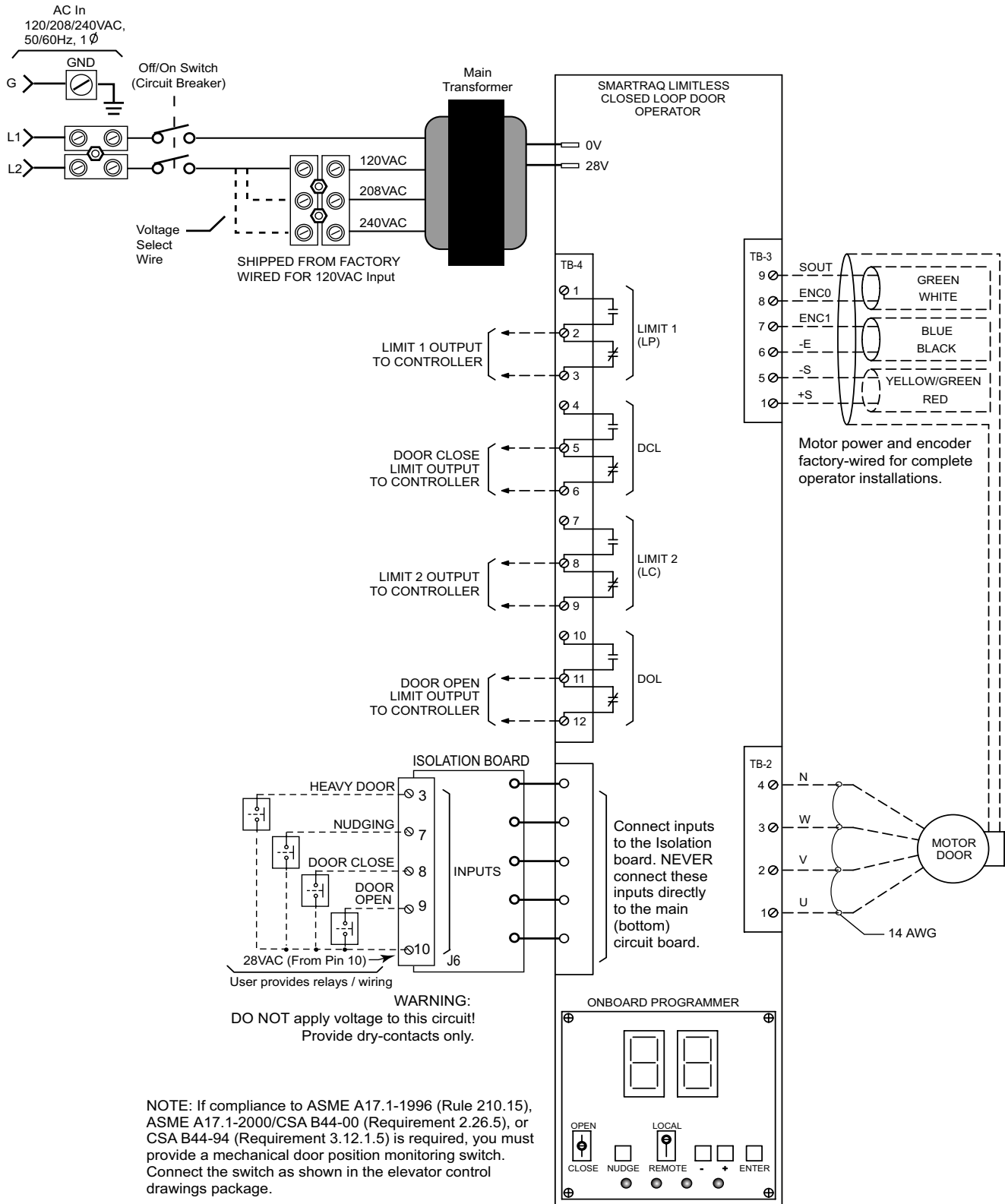

Figure 3. SmarTraq Wiring Diagram



Cable Access

The SmarTraq drive enclosure is designed with easy field access in mind. There are access plates on the enclosure that simplify command signal control and motor connections. The plates have multiple access holes sized to accept 1/2" conduit collars and fittings. Plates are secured to the drive enclosure using four phillips-head screws.

When making connections, you can remove the plates and easily attach conduit hardware, fit wire ends to plug-in connectors, plug in the connectors, then re-attach the plates. When removing a drive, you can unplug connectors, detach the access plates, and remove the drive enclosure.



Caution

If you need to enlarge the conduit holes, REMOVE the plates and perform the operation OUTSIDE the drive to avoid damaging drive components or getting metal debris inside the enclosure. Damage caused by tools or metal debris is NOT COVERED by warranty.

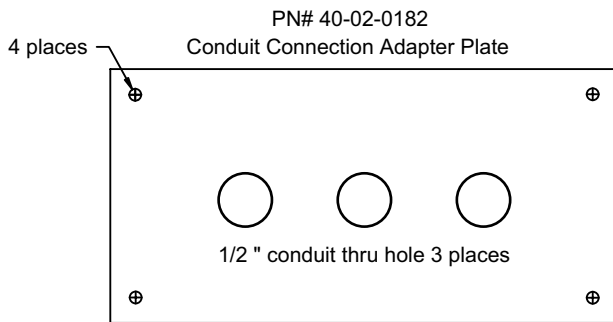

If you need to order a replacement conduit access plate, order PN# 42-02-0182.

The circuit board assembly is also attached to an easy-access plate. If there is a circuit board related failure, you can easily unplug motor encoder and control connections, unplug power connections, remove the grounding screw, remove the four access plate screws and slide the entire board assembly out of the enclosure for the fastest possible replacement time. [Please refer to “Board Set Replacement” on page 39.](#)

Control Input Wiring and Verification

Connect door control inputs from the elevator controller to SmarTraq inverter drive **Isolation board connector J6**. These inputs must be supplied by dry contact closures only.



Caution

Any external voltages connected to terminals 3, 7, 8, 9, or 10 will damage the drive and void the drive warranty. **DO NOT** make **input** connections to the Main board (bottom board in drive enclosure).

Figure 4. SmarTraq Circuit Boards

Programmer board (top board)

Isolation board (middle board)
Connector J6

Main board (bottom board)

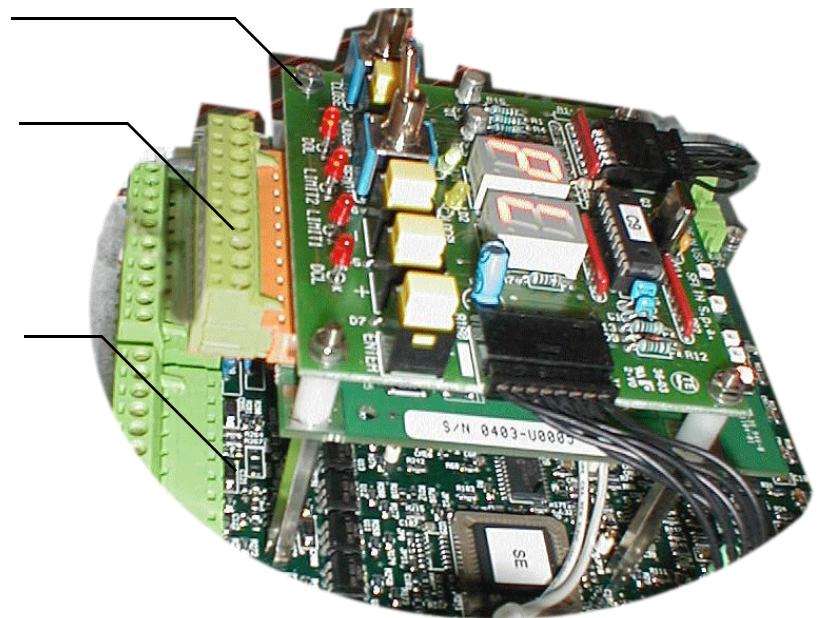

Referring to the preceding SmarTraq wiring diagram and to the following verification drawing, note that, when closed, the dry contact closures provide a connection between the associated control input (HD, DC, or DO) and terminal 10 on the J6 connector. These connections should be detailed on the job prints supplied by the controller manufacturer. However, especially when upgrading or retrofitting, you may have to provide relays or reuse existing relays to provide these contact closures.

The illustration below provides an example of how to use a voltmeter to test the state (open/closed) of the dry contacts.

Figure 5. Verifying Contact States at J6 Door Control Inputs

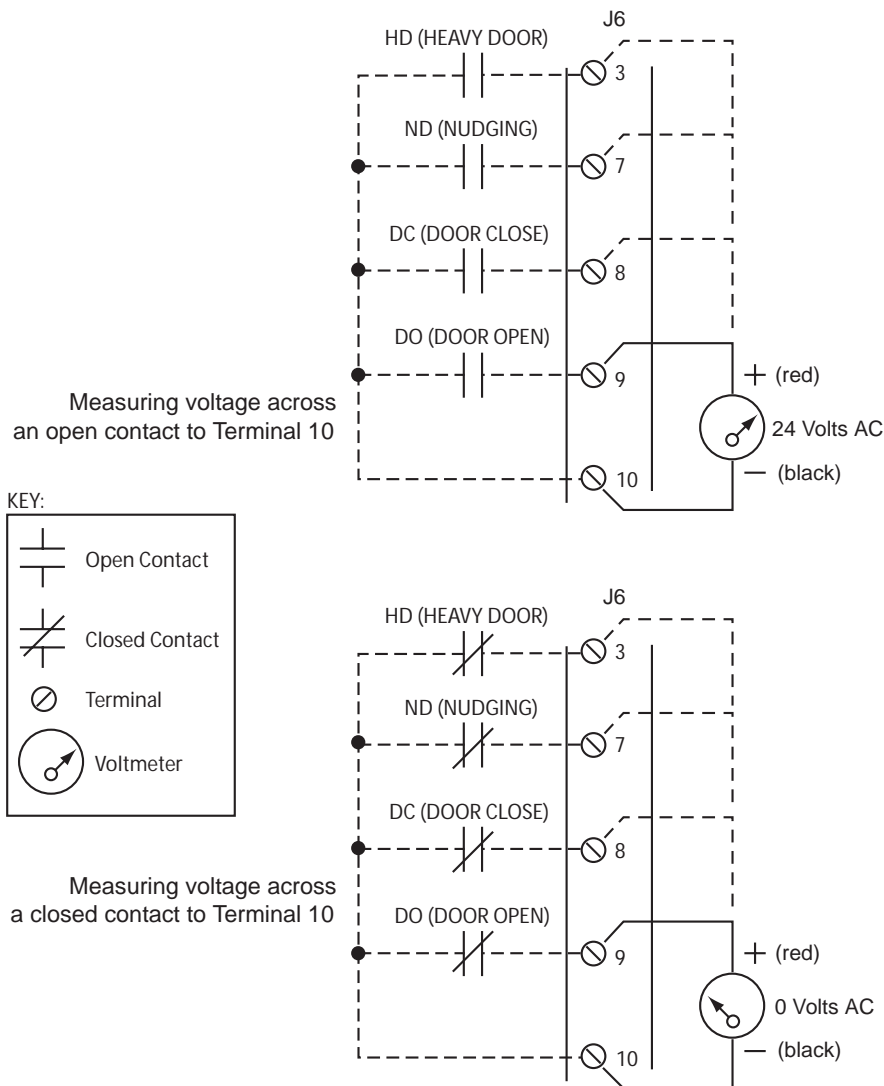

Product Specifications

SmarTraq uses a permanent-magnet, brushless motor with a built-in encoder and a microprocessor-based inverter drive.

Table 1. SmarTraq Specifications, Interface Data, and Code Compliance

Door Operator Drive Technical Data	
Input Voltage	120/208/240VAC, 50/60Hz, Single-phase
Output Voltage	3-Phase, 30VAC, 9A (26A peak)
Power Requirement	300VA
Controller Type	Closed Loop, Distance and Velocity Feedback, Limitless
Door Motor Technical Data	
Type	Three-phase, synchronous, brushless motor with permanent magnet excitation and built-in digital encoder
Motor	0.564 HP, 3-Phase AC, 8-Pole, 30 Volt, 9A (26A peak), 0 — 2000 RPM, 0 — 133Hz
Encoder	640 PPR (Pulses Per Revolution)
Elevator Control Interface Data	
Input Signals	Door Open Door Close Nudging Heavy Door
Input Signal Level	Dry Contact
Output Signals	Door Open Limit Door Close Limit Limit 1 Limit 2
Output Signal Level	N.O./N.C. Contact, 10 Amp
Code Compliance	
For ASME A17.1-1996 (Rule 210.15), ASME A17.1-2000/CSA B44-00 (Requirement 2.26.5), or CSA B44-94 (Requirement 3.12.1.5) compliance, mechanical Door Position Monitoring Switch must be provided.	

Figure 6. Typical SmarTraq Harmonic Operator

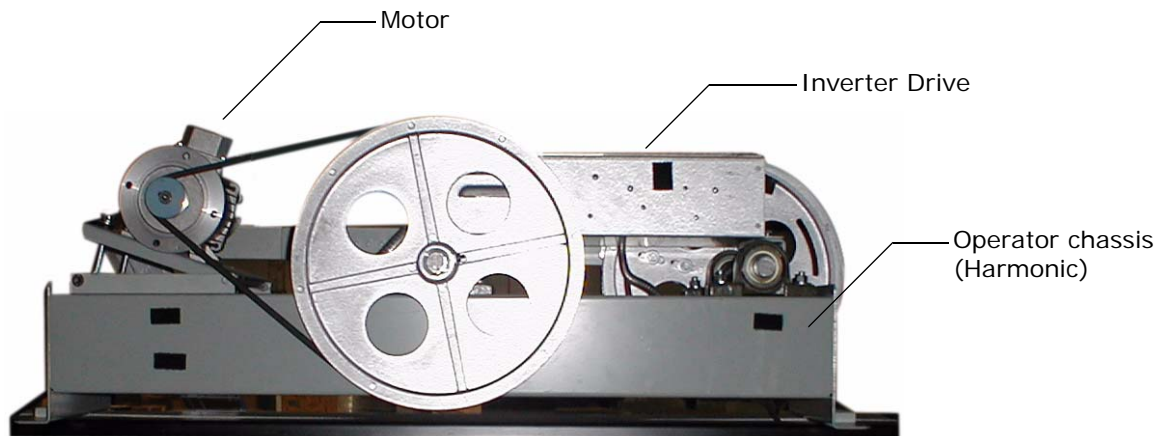

SmarTraq Adjustments

This section describes:

- Checking motor rotation
- [SmarTraq Programmer Controls](#)
- [Learning Full Open and Full Close positions](#)
- [Verifying Operation](#)
- [Adjusting parameters](#)

Checking Motor Rotation

Motor control connections from inverter drive terminals TB2 and TB3 to the motor assume clockwise motor rotation when the elevator doors are closing. It is important to verify that this is the case:

1. **Manually open and close** elevator doors while watching motor rotation.
2. Viewed from the motor shaft end, motor must rotate clockwise when doors are closing.
If so, connections shown in the wiring diagram and in the table below are correct:

Table 2. Motor Connections from Wiring Diagram

Motor	TB2 Connector
U1	Terminal 1
V1	Terminal 2
W1	Terminal 3
N	Terminal 4
TB3 Connector	
SOUT	Terminal 9
ENC0 (white)	Terminal 8
ENC1 (blue)	Terminal 7
-E	Terminal 6
-S	Terminal 5
+S	Terminal 1

3. If, as viewed from the shaft end, motor rotates counter-clockwise when doors are closing, connections must be changed as shown in the following table:

Table 3. Motor Connections if Rotation is Counter-Clockwise as Doors Close

Motor	TB2 Connector
U1	Terminal 1
V1	Terminal 3 (changed)
W1	Terminal 2 (changed)
N	Terminal 4
TB3 Connector	
SOUT	Terminal 9
ENC0 (white)	Terminal 7 (changed)
ENC1 (blue)	Terminal 8 (changed)
-E	Terminal 6
-S	Terminal 5
+S	Terminal 1

SmarTraq Programmer Controls

Doors can be controlled from the inverter drive unit using programmer switches and displays located on the programmer (top) board. Read this page, then perform the door learning procedure on the following page. **When initially installed, the DCL (Door Close Limit) must be established before parameters can be changed.**

Figure 7. Inverter Drive Programmer Switches

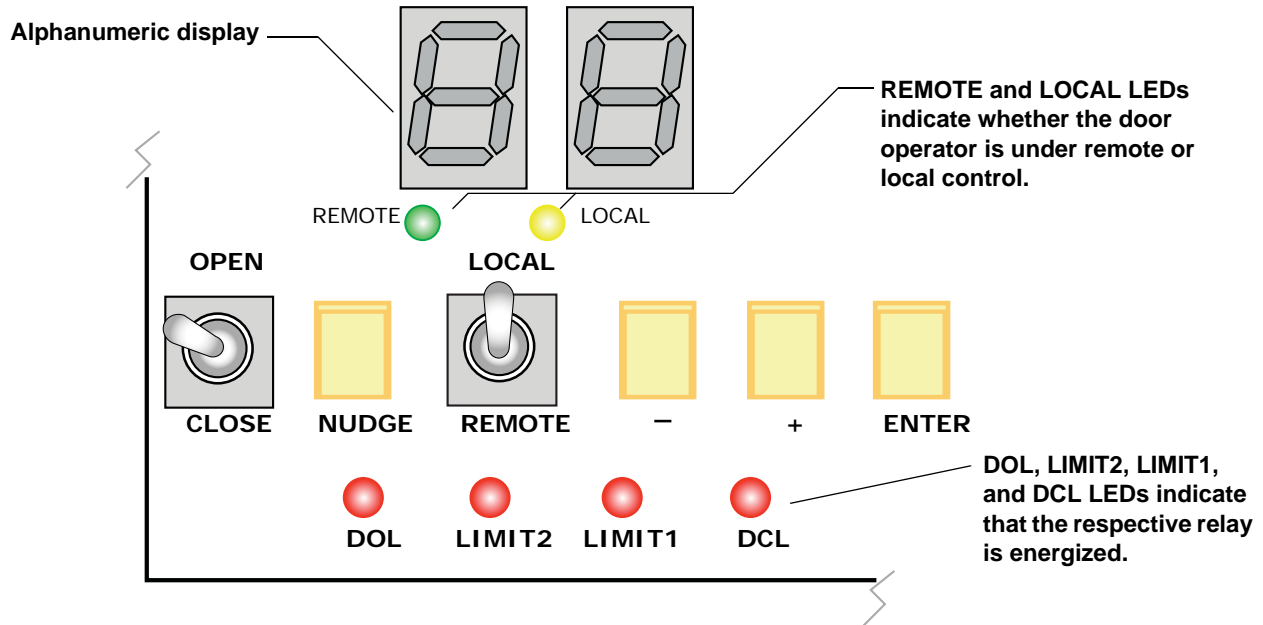

Programmer controls include:

- **Alphanumeric display:** Displays parameters. Displays numeric value of a selected parameter (0 to 31). Higher number = higher value.
- **Remote and Local LEDs:** Indicate the current setting of the Local/Remote toggle switch. When Remote is lighted, the elevator controller is controlling the drive. When Local is lighted, the programmer switches are controlling the drive.
- **Open/Close:** Three-position, spring-loaded switch active when Local control is selected:
 - Open: Hold in Open position to open elevator doors.
 - Close: Hold in Close position to close elevator doors.
- **Nudge:** Hold Close switch and press Nudge to close elevator doors at nudging (reduced) speed.
- **Local/Remote:** Two-position toggle switch, selecting:
 - Local: Local inverter drive control (from programmer switches)
 - Remote: Remote inverter drive control (from elevator controller)
- **- and +:** Push buttons. Used to select a parameter to be adjusted and to change value of a parameter after it is selected.
- **Enter:** After toggling to a parameter using the + and - buttons, press Enter to select that parameter for adjustment. After adjusting a value using the + and - buttons, press Enter to place the new value in local memory. To return to operating mode, use + or - buttons to toggle the alphanumeric display to "do", then press Enter.



Learning Full Open and Full Close Positions

The operator learns open and close limits when current rises to preset limits (C1 open, C3 close) when doors reach full open or full close. Once limits are learned, SmarTraq is able to distinguish between an obstruction and full open or close positions. DOL (Door Open Limit) and DCL (Door Close Limit) can be learned only in the last 1/2" (13 mm) of door travel in either direction.

- Doors Full Open: Door Open Limit is energized and programmer board DOL LED lights
- Doors Full Closed: Door Close Limit is energized and programmer board DCL LED lights

Establishing DCL





One of the parameters programmed into the drive is C3, closing torque. In order to establish the Door Close Limit, the operator must close the doors and continue applying closing torque until the C3 value is achieved. At that point, the DCL LED on the programmer board will light and the programmer display will "say" Lr. Once Lr is displayed, you are able to cycle through and change parameter values, even before performing a "door learn" operation.

1. Verify that elevator doors are closed.
2. Place Local/Remote switch in the **Local** position.
3. Turn power **ON**.

For a few seconds, dashes will be displayed on the LED display. Then, the dash on the right hand display will disappear. The inverter drive is ready to accept input. 

4. Hold the Open/Close switch in the Close position. The doors will close. The DCL LED will light and Lr will be displayed. The motor may cog to establish DCL. (The doors may actually move open slightly before closing because the operator does not "know" its position yet.)

If DCL is not Established: During test, default values are programmed into the door operator. The door opening and the door weight on the test unit may be very different from your field installation needs. It is also possible that the C3 value programmed is too high for your installation. Any of these conditions can prevent the operator from being able to establish DCL. If the operator cannot establish DCL:

1. Open the door slightly.
2. Shut the drive switch OFF.
3. Hold the Open/Close switch in the CLOSE position.
4. Continue to hold the switch in the CLOSE position while turning power back ON.
5. The door will close and establish DCL. Once the DCL LED has lighted, release the Open/Close switch. (If DCL is still not established, repeat steps 1 through 5 until it is.)
6. The display will show .
7. Press the + (or -) button until  is displayed. Press ENTER to display the stored C3 setting.
8. Use the + or - button the set the value to 10. Press Enter to enter the new value.
9. Press the + or - button until  is displayed. Press Enter to save changes to memory.  will be displayed.

If your doors are very heavy or very light, a C3 value of 10 may be too little or too much and not move the doors properly during the learn operation or regular opening and closing. If so adjust C3 value two "steps" at a time until the closing torque applied is right for your doors.

Performing the Learn Operation

After DCL is established as described in the preceding paragraphs and Lr is displayed, you can complete the door learn operation.



1. Press Enter.

The doors will automatically open at low speed to FULL OPEN position to establish DOL and then automatically close at low speed to FULL CLOSE position. Learning is complete.

Note

It is very unusual, but if the operator fails to recognize DOL when the doors reach full open during the initial, slow, learn cycle, it is probably because the operator belt is too loose and is slipping. You want the belt tight enough that it will not slip but not so tight that it causes noisy operation.

It is also possible that the C1 (door opening torque/current) parameter is set too high. You want C1 set to provide good opening performance but not so high that it forces an adequately tightened belt to slip when the doors reach their maximum open position. If this is the case:

- Press the + (or -) button until  is displayed. Press ENTER to display the stored C1 setting.
- Use the - button to reduce the value two “steps.” Press Enter to enter the new value.
- Press the + or - button until  is displayed. Press Enter to save changes to memory.  will be displayed.
- Repeat the learn operation.

Note

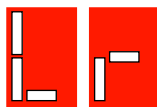

is displayed during normal operation after all parameters have been entered and door limits have been learned.

Verifying Door Operation

Note

Whenever power is turned on (cycled) to the SmarTraq drive, the first open operation will be at Low Speed.

To verify door operation:

1. Hold Open/Close in Open position. Doors will open and detect Full Open position. DOL should be displayed.
2. Hold Open/Close in Close position. Doors will close and detect Full Close position. DCL should be displayed.

Door Operation Example

When in Local mode, you can operate the doors using the programmer switches.

To open the doors:

- Hold the Open/Close switch to Open. Pause at any point if desired. The Limit 2 LED will light at some (user adjustable, LC parameter) point as the doors are opening. When the Door Open Limit is reached (DOL relay energized), the DOL LED will light.

To close the doors:

- Hold the Open/Close switch to Close. Pause at any point if desired. The Limit 1 LED will light at some (user adjustable, LP parameter) point as the doors are closing. When the Door Close Limit is reached (DCL relay energized), the DCL LED will light.

To close at nudging speed:

- Hold the Open/Close switch to Close. Press the Nudge button. The doors will close at reduced speed.

Adjusting Parameters

All door operator adjustments are made by selecting and changing parameters using inverter drive programmer switches. All parameter values are numeric, from 0 to 31. The higher the number, the greater the parameters effect.



Note

Parameter values can only be changed or viewed when elevator doors are Full Closed and Door Close Limit LED is lighted.

After changing parameters, you must select the parameter “do” and press Enter to save the changes. If you change a torque value (marked with an * in the table), you must perform a door learn operation after saving changes. To return to automatic door operation, place the Local/Remote switch back in Remote position. (Otherwise, the operator will not respond to open or close commands from the elevator controller.)

Use the following table and the Motion Profile illustration to adjust parameters.

Table 4. Inverter Drive Parameters

Parameter	Description
PL	Start Open Position: Position where doors start to accelerate. Higher value = Position farther from full close.
P2	Open Slowdown Position: Position where doors begin to decelerate from high to low opening speed. Higher value = deceleration nearer to full open position.
P7	Close Slowdown Position: Position where doors begin to decelerate from high to low closing speed. Higher value = deceleration nearer to full close position.
Po	Reopen Slowdown Position: Higher value = Reopen slowdown position starts nearer to full open.
Pc	Reclose Slowdown Position: Higher value = Reclose slowdown position starts nearer full close.
Pr	Reopen Distance: Distance from full open where Po parameter, Reopen Slowdown Position, and Ar parameter, Reopen Deceleration, can be activated. 00 value = from full open to 75% of full open. Setting parameter from 01 to 31 = from 75% of full open to 25% of full open. Note: Most door operators will not require adjustment of this parameter. This parameter is factory set to 00. Should be set to 00 unless absolutely necessary. See Caution following this table.
U0	Start Open Speed: Higher value = More speed.
U1	High Opening Speed: Higher value = More speed.
U2	Low Opening Speed: Higher value = More speed.
U3	High Closing Speed: Higher value = More speed.
U4	Low Closing Speed: Higher value = More speed.
Ud	Nudging Speed: Higher value = More speed.
A0	Opening Acceleration: Higher value = Faster acceleration.
A1	Opening Deceleration: Higher value = Faster deceleration.
A2	Closing Acceleration: Higher value = Faster acceleration.
A3	Closing Deceleration: Higher value = Faster deceleration.
Ab	Braking Deceleration: Deceleration during door reversal. Higher value = More deceleration.
Ar	Reopen Deceleration: Higher value = Faster deceleration.
F3	Heavy Door High Closing Speed: Higher value = More speed. This value must be lower than U3.

Table 4. Inverter Drive Parameters

Parameter	Description
F7	Heavy Door Close Slowdown Position: Position where doors begin to decelerate from high to low closing speed. Higher value = deceleration nearer to full close position.
Fd	Heavy Door Nudging Speed: Higher values = More Speed.
*C1	Maximum current threshold to establish DOL. Set according to operator characteristics. Heavy doors and/or a geared operator that requires high torque will require a higher setting. Light doors requiring low torque can use a lower setting. If set too high, may cause belt slippage and failure to establish DOL.
*C2	Maximum allowed opening torque before DOL is detected. Find the setting appropriate to performance needs and door conditions, then increase it by 2.
*C3	Maximum allowed closing torque during normal operation: Higher value = More torque. See the Door Closing Time compliance tables.
*Co	Hold Open Torque: Higher value = More torque. Torque when doors are full open regardless of the state of the Open command.
*Cc	Hold Close Torque with Close command active: Higher value = More torque. Set to the minimum necessary to keep the door closed.
*Cr	Hold Close Torque when Close command is NOT active. Set to minimum necessary to keep the door open.
*Cd	Maximum allowed torque during nudging door closing. See the Door Closing Time compliance tables.
*Cb	Braking torque: Limits braking torque during slowdown. Higher Value = More braking torque. Lower Value = Less braking torque. 00 value = no effect. Should be set to 00 unless absolutely necessary to set otherwise. See Caution following this table.
LP	Limit 1: Higher value = Output turns on when doors are nearer to close position. Lower value = Output turns on when doors are farther from full close position.
LC	Limit 2: Higher value = Output turns on when doors are nearer to open position. Lower value = Output turns on when doors are farther from full open position.
do	Select Operation Mode: Once a parameter is adjusted, operation mode must be selected. Otherwise, door operator will not respond to open or close commands.
Lr	Learn Command:



Any time the door torque parameters are changed, the Learn process must be repeated. Torque parameters are marked with an * in the preceding table.



Caution

Pr and Cb parameters should always be set to “00” unless it is absolutely necessary to set them otherwise. [Please refer to “Opening and Closing” on page 33 for Cb.](#) [Please refer to “Reopening and Reclosing” on page 34 for Pr.](#)

Figure 8. Motion Profile

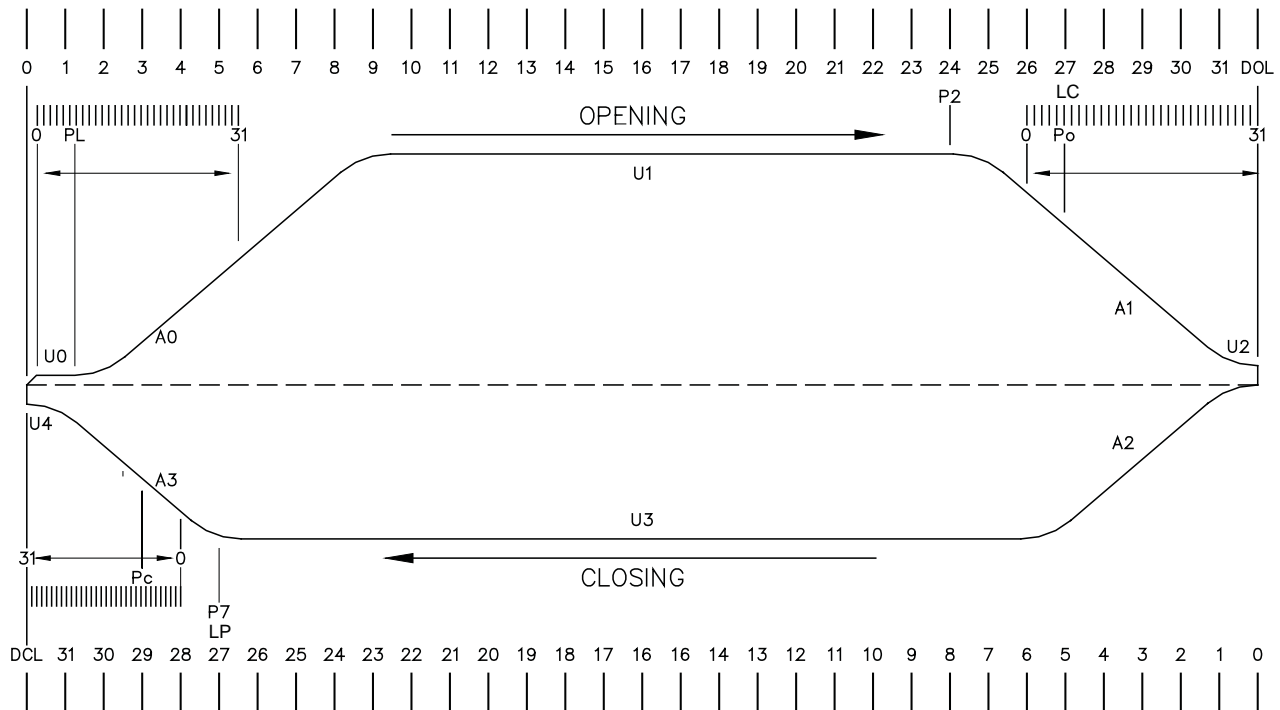

Parameter Adjustment Example

To adjust a parameter (U1, high opening speed, in this example):

1. Check that the elevator doors are fully closed.

Note

Parameter values can only be changed or viewed when elevator doors are Full Closed and Door Close Limit LED is lighted.

2. Place the Local/Remote switch in the Local position.
3. If necessary, hold the Open/Close switch to Close until the alphanumeric display shows "Lr" and DCL LED is illuminated.
4. Use the + and/or - buttons to toggle to the desired parameter (U1 in this example).
5. Press Enter. The current value of the parameter will be displayed (0 - 31).
6. Use the + and/or - buttons to change the value.
7. When the desired value is displayed, press Enter to hold it in local memory.
8. If desired, continue setting additional parameters.
9. When ready to save your changes, use the + and - buttons to change the display to "do", then press Enter.
10. Place the Local/Remote switch back to the Remote position.

Note

After adjusting a torque parameter, always re-learn Open/Close limits. Please refer to "Learning Full Open and Full Close Positions" on page 13.

Measuring Door Closing Force

To measure door closing force:

1. Park the car at a floor.
2. Begin to close the doors. Allow them to close 1/3 to 2/3 of their normal travel, then stop them.
3. Insert a force measuring device appropriate to measure 30 lbf against the stopped door. Slowly release the doors so that they are now held stationary by the measuring device.
4. Slowly back off on the device until the door just starts to move. At this point, the door and measuring forces are approximately equal and the closing force value may be read.

Door Closing Time Compliance

If you are installing a job in a jurisdiction requiring compliance to Requirement 2.13.4.2.4 of ASME A17.1-2000 you must apply one of the Door Data Plate labels included with this manual to the door operator or crosshead. The data tags must be properly completed to show:

- Month and year of installation
 - Typical floor door mass
 - Minimum code closing time (resulting in average kinetic energy of less than 7.37 foot pounds) at normal closing speed with typical floor door mass
 - Minimum code closing time (resulting in average kinetic energy of less than 2.50 foot pounds) at reduced/nudging closing speed with typical floor door mass
- Heavy door mass (where applicable) and landings affected
 - Minimum code closing time (resulting in average kinetic energy of less than 7.37 foot pounds) at normal closing speed with heavy door mass
 - Minimum code closing time (resulting in average kinetic energy of less than 2.50 foot pounds) at reduced/nudging closing speed with heavy door mass

The “Minimum Closing Time” tables on the following pages reflect an average kinetic energy of 7.37 foot pounds (2.50 foot pounds, nudging) and provide the minimum code closing times for most normal door configurations and sizes (normal and nudging operation).

When using the tables, consider:

- Closing Time/Distance: For side opening doors, code distance starts two-inches (2”) from the jamb and ends two-inches (2”) from full close. For center opening doors, code distance starts one-inch (1”) from the jamb and ends one-inch (1”) from full close.
- Average Kinetic Energy (7.37 foot pounds): Table times are based on this energy calculation. Calculations include “equipment rigidly connected thereto”, all hangers, rollers, clutches, releases, closers, and reopening devices, and the rotational inertia of the motor and operator.
- Actual Kinetic Energy (peak energy, 17.00 foot pounds): Using MCE equipment and following instructions carefully, you should not exceed the actual kinetic energy requirement if your door closing time complies with the time shown in the table for your door.
- Reduced/Nudging Kinetic Energy (2.50 foot pounds): If the performance requirements of the job allow, nudging speed closing time can safely be calculated as twice the normal closing time. If performance demands greater speed, please contact MCE Technical Support for assistance.

Table 5. Center Parting Doors

		MINIMUM CLOSING TIME FOR CENTER PARTING DOORS (sec)																							
		26	28	30	32	34	36	38	40	42	44	46	48	50	52	54	56	58	60	62	64	66			
Door Opening Width (inch)	(1) Code Zone Distance (inch)	11	12	13	14	15	16	17	18	19	20	21	22	23	24	25	26	27	28	29	30	31			
	100	0.42	0.46	0.50	0.54	0.57	0.61	0.65	0.69	0.73	0.77	0.80	0.84	0.88	0.92	0.96	0.99	1.03	1.07	1.11	1.15	1.19			
	150	0.52	0.56	0.61	0.66	0.70	0.75	0.80	0.84	0.89	0.94	0.98	1.03	1.08	1.12	1.17	1.22	1.26	1.31	1.36	1.41	1.45			
	200	0.60	0.65	0.70	0.76	0.81	0.87	0.92	0.97	1.03	1.08	1.14	1.19	1.24	1.30	1.35	1.41	1.46	1.51	1.57	1.62	1.68			
	250	0.67	0.73	0.79	0.85	0.91	0.97	1.03	1.09	1.15	1.21	1.27	1.33	1.39	1.45	1.51	1.57	1.63	1.69	1.75	1.81	1.87			
	300	0.73	0.80	0.86	0.93	0.99	1.06	1.13	1.19	1.26	1.33	1.39	1.46	1.52	1.59	1.66	1.72	1.79	1.86	1.92	1.99	2.05			
	350	0.79	0.86	0.93	1.00	1.07	1.14	1.22	1.29	1.36	1.43	1.50	1.57	1.65	1.72	1.79	1.86	1.93	2.00	2.08	2.15	2.22			
	400	0.84	0.92	0.99	1.07	1.15	1.22	1.30	1.38	1.45	1.53	1.61	1.68	1.76	1.84	1.91	1.99	2.07	2.14	2.22	2.30	2.37			
	450	0.89	0.97	1.05	1.14	1.22	1.30	1.38	1.46	1.54	1.62	1.70	1.79	1.87	1.95	2.03	2.11	2.19	2.27	2.35	2.43	2.52			
	500	0.94	1.03	1.11	1.20	1.28	1.37	1.45	1.54	1.63	1.71	1.80	1.88	1.97	2.05	2.14	2.22	2.31	2.39	2.48	2.57	2.65			
	550	0.99	1.08	1.17	1.26	1.35	1.44	1.53	1.61	1.70	1.79	1.88	1.97	2.06	2.15	2.24	2.33	2.42	2.51	2.60	2.69	2.78			
	600	1.03	1.12	1.22	1.31	1.41	1.50	1.59	1.69	1.78	1.87	1.97	2.06	2.15	2.25	2.34	2.44	2.53	2.62	2.72	2.81	2.90			
	650	1.07	1.17	1.27	1.37	1.46	1.56	1.66	1.76	1.85	1.95	2.05	2.15	2.24	2.34	2.44	2.54	2.63	2.73	2.83	2.93	3.02			
	700	1.11	1.21	1.32	1.42	1.52	1.62	1.72	1.82	1.92	2.02	2.13	2.23	2.33	2.43	2.53	2.63	2.73	2.83	2.93	3.04	3.14			
	750	1.15	1.26	1.36	1.47	1.57	1.68	1.78	1.89	1.99	2.10	2.20	2.30	2.41	2.51	2.62	2.72	2.83	2.93	3.04	3.14	3.25			
	800	1.19	1.30	1.41	1.51	1.62	1.73	1.84	1.95	2.06	2.16	2.27	2.38	2.49	2.60	2.70	2.81	2.92	3.03	3.14	3.25	3.35			
	850	1.23	1.34	1.45	1.56	1.67	1.78	1.90	2.01	2.12	2.23	2.34	2.45	2.56	2.68	2.79	2.90	3.01	3.12	3.23	3.35	3.46			
	900	1.26	1.38	1.49	1.61	1.72	1.84	1.95	2.07	2.18	2.30	2.41	2.52	2.64	2.75	2.87	2.98	3.10	3.21	3.33	3.44	3.56			
	950	1.30	1.41	1.53	1.65	1.77	1.89	2.00	2.12	2.24	2.36	2.48	2.59	2.71	2.83	2.95	3.07	3.18	3.30	3.42	3.54	3.65			
	1000	1.33	1.45	1.57	1.69	1.81	1.94	2.06	2.18	2.30	2.42	2.54	2.66	2.78	2.90	3.02	3.14	3.27	3.39	3.51	3.63	3.75			
	1050	1.36	1.49	1.61	1.74	1.86	1.98	2.11	2.23	2.35	2.48	2.60	2.73	2.85	2.97	3.10	3.22	3.35	3.47	3.59	3.72	3.84			
	1100	1.40	1.52	1.65	1.78	1.90	2.03	2.16	2.28	2.41	2.54	2.66	2.79	2.92	3.04	3.17	3.30	3.43	3.55	3.68	3.81	3.93			
	1150	1.43	1.56	1.69	1.82	1.95	2.08	2.21	2.33	2.46	2.59	2.72	2.85	2.98	3.11	3.24	3.37	3.50	3.63	3.76	3.89	4.02			
	1200	1.46	1.59	1.72	1.86	1.99	2.12	2.25	2.39	2.52	2.65	2.78	2.92	3.05	3.18	3.31	3.45	3.58	3.71	3.84	3.98	4.11			

(2) Combined Weight of Car and Hoistway Attached Equipment (lbs)

NOTES:

- (1) See Section 2.13.4.2.1 of ASME A17.1 Safety Code for Elevators for details
- (2) See Section 2.13.4.2.2 of ASME A17.1 Safety Code for Elevators for details

Kinetic Energy Formula

$$1/2 \left(\frac{M}{32.2} \right) (V)^2 = 7.37 \text{ ft-lbf}$$

M = Combined Weight of Car and Hoistway Doors and All Attached Equipment
 V = Speed in Feet Per Second

Table 7. Side Slide Doors

		MINIMUM CLOSING TIME FOR SIDE SLIDE DOORS (sec)																							
Door Opening Width (inch)	26	28	30	32	34	36	38	40	42	44	46	48	50	52	54	56	58	60	62	64	66				
(1) Code Zone Distance (inch)	22	24	26	28	30	32	34	36	38	40	42	44	46	48	50	52	54	56	58	60	62				
100	0.84	0.92	0.99	1.07	1.15	1.22	1.30	1.38	1.45	1.53	1.61	1.68	1.76	1.84	1.91	1.99	2.07	2.14	2.22	2.30	2.37				
150	1.03	1.12	1.22	1.31	1.41	1.50	1.59	1.69	1.78	1.87	1.97	2.06	2.15	2.25	2.34	2.44	2.53	2.62	2.72	2.81	2.90				
200	1.19	1.30	1.41	1.51	1.62	1.73	1.84	1.95	2.06	2.16	2.27	2.38	2.49	2.60	2.70	2.81	2.92	3.03	3.14	3.25	3.35				
250	1.33	1.45	1.57	1.69	1.81	1.94	2.06	2.18	2.30	2.42	2.54	2.66	2.78	2.90	3.02	3.14	3.27	3.39	3.51	3.63	3.75				
300	1.46	1.59	1.72	1.86	1.99	2.12	2.25	2.39	2.52	2.65	2.78	2.92	3.05	3.18	3.31	3.45	3.58	3.71	3.84	3.98	4.11				
350	1.57	1.72	1.86	2.00	2.15	2.29	2.43	2.58	2.72	2.86	3.01	3.15	3.29	3.43	3.58	3.72	3.86	4.01	4.15	4.29	4.44				
400	1.68	1.84	1.99	2.14	2.30	2.45	2.60	2.75	2.91	3.06	3.21	3.37	3.52	3.67	3.83	3.98	4.13	4.28	4.44	4.59	4.74				
450	1.79	1.95	2.11	2.27	2.43	2.60	2.76	2.92	3.08	3.25	3.41	3.57	3.73	3.89	4.06	4.22	4.38	4.54	4.71	4.87	5.03				
500	1.88	2.05	2.22	2.39	2.57	2.74	2.91	3.08	3.25	3.42	3.59	3.76	3.93	4.11	4.28	4.45	4.62	4.79	4.96	5.13	5.30				
550	1.97	2.15	2.33	2.51	2.69	2.87	3.05	3.23	3.41	3.59	3.77	3.95	4.13	4.31	4.49	4.66	4.84	5.02	5.20	5.38	5.56				
600	2.06	2.25	2.44	2.62	2.81	3.00	3.19	3.37	3.56	3.75	3.94	4.12	4.31	4.50	4.68	4.87	5.06	5.25	5.43	5.62	5.81				
650	2.15	2.34	2.54	2.73	2.93	3.12	3.32	3.51	3.71	3.90	4.10	4.29	4.49	4.68	4.88	5.07	5.27	5.46	5.66	5.85	6.05				
700	2.23	2.43	2.63	2.83	3.04	3.24	3.44	3.64	3.85	4.05	4.25	4.45	4.66	4.86	5.06	5.26	5.46	5.67	5.87	6.07	6.27				
750	2.30	2.51	2.72	2.93	3.14	3.35	3.56	3.77	3.98	4.19	4.40	4.61	4.82	5.03	5.24	5.45	5.66	5.87	6.08	6.29	6.49				
800	2.38	2.60	2.81	3.03	3.25	3.46	3.68	3.89	4.11	4.33	4.54	4.76	4.98	5.19	5.41	5.63	5.84	6.06	6.28	6.49	6.71				
850	2.45	2.68	2.90	3.12	3.35	3.57	3.79	4.01	4.24	4.46	4.68	4.91	5.13	5.35	5.58	5.80	6.02	6.25	6.47	6.69	6.91				
900	2.52	2.75	2.98	3.21	3.44	3.67	3.90	4.13	4.36	4.59	4.82	5.05	5.28	5.51	5.74	5.97	6.20	6.43	6.66	6.89	7.11				
950	2.59	2.83	3.07	3.30	3.54	3.77	4.01	4.24	4.48	4.72	4.95	5.19	5.42	5.66	5.89	6.13	6.37	6.60	6.84	7.07	7.31				
1000	2.66	2.90	3.14	3.39	3.63	3.87	4.11	4.35	4.60	4.84	5.08	5.32	5.56	5.81	6.05	6.29	6.53	6.77	7.02	7.26	7.50				
1050	2.73	2.97	3.22	3.47	3.72	3.97	4.21	4.46	4.71	4.96	5.21	5.45	5.70	5.95	6.20	6.45	6.69	6.94	7.19	7.44	7.68				
1100	2.79	3.04	3.30	3.55	3.81	4.06	4.31	4.57	4.82	5.07	5.33	5.58	5.84	6.09	6.34	6.60	6.85	7.10	7.36	7.61	7.87				
1150	2.85	3.11	3.37	3.63	3.89	4.15	4.41	4.67	4.93	5.19	5.45	5.71	5.97	6.23	6.49	6.75	7.00	7.26	7.52	7.78	8.04				
1200	2.92	3.18	3.45	3.71	3.98	4.24	4.51	4.77	5.04	5.30	5.57	5.83	6.10	6.36	6.63	6.89	7.16	7.42	7.69	7.95	8.22				

(2) Combined Weight of Car and Hoistway Doors and All Attached Equipment (lbs)

NOTES:

- (1) See Section 2.13.4.2.1 of ASME A17.1 Safety Code for Elevators for details
- (2) See Section 2.13.4.2.2 of ASME A17.1 Safety Code for Elevators for details

Kinetic Energy Formula

$$\frac{1}{2} \left(\frac{M}{32.2} \right) (V)^2 = 7.37 \text{ ft-lbf}$$

M = Combined Weight of Car and Hoistway Doors and All Attached Equipment
 V = Speed in Feet Per Second

Table 8. Side Slide Doors without Re-Opening (Nudging) Device

		MINIMUM CLOSING TIME FOR SIDE SLIDE DOORS WITHOUT RE-OPENING DEVICE (NUDGING) (sec)																							
Door Opening Width (inch)		26	28	30	32	34	36	38	40	42	44	46	48	50	52	54	56	58	60	62	64	66			
(1) Code Zone Distance (inch)		22	24	26	28	30	32	34	36	38	40	42	44	46	48	50	52	54	56	58	60	62			
100	1.44	1.58	1.71	1.84	1.97	2.10	2.23	2.36	2.50	2.63	2.76	2.89	3.02	3.15	3.28	3.42	3.55	3.68	3.81	3.94	4.07	4.20			
150	1.77	1.93	2.09	2.25	2.41	2.57	2.73	2.90	3.06	3.22	3.38	3.54	3.70	3.86	4.02	4.18	4.34	4.50	4.67	4.83	4.99	5.15			
200	2.04	2.23	2.41	2.60	2.79	2.97	3.16	3.34	3.53	3.72	3.90	4.09	4.27	4.46	4.64	4.83	5.02	5.20	5.39	5.57	5.76	5.94			
250	2.28	2.49	2.70	2.91	3.12	3.32	3.53	3.74	3.95	4.15	4.36	4.57	4.78	4.98	5.19	5.40	5.61	5.82	6.02	6.23	6.44	6.64			
300	2.50	2.73	2.96	3.19	3.41	3.64	3.87	4.10	4.32	4.55	4.78	5.01	5.23	5.46	5.69	5.92	6.14	6.37	6.60	6.83	7.05	7.28			
350	2.70	2.95	3.19	3.44	3.69	3.93	4.18	4.42	4.67	4.91	5.16	5.41	5.65	5.90	6.14	6.39	6.63	6.88	7.13	7.37	7.62	7.86			
400	2.89	3.15	3.42	3.68	3.94	4.20	4.47	4.73	4.99	5.25	5.52	5.78	6.04	6.30	6.57	6.83	7.09	7.36	7.62	7.88	8.14	8.40			
450	3.07	3.34	3.62	3.90	4.18	4.46	4.74	5.02	5.29	5.57	5.85	6.13	6.41	6.69	6.97	7.24	7.52	7.80	8.08	8.36	8.64	8.91			
500	3.23	3.52	3.82	4.11	4.41	4.70	4.99	5.29	5.58	5.87	6.17	6.46	6.76	7.05	7.34	7.64	7.93	8.22	8.52	8.81	9.11	9.40			
550	3.39	3.70	4.00	4.31	4.62	4.93	5.24	5.54	5.85	6.16	6.47	6.78	7.09	7.39	7.70	8.01	8.32	8.63	8.93	9.24	9.55	9.85			
600	3.54	3.86	4.18	4.50	4.83	5.15	5.47	5.79	6.11	6.43	6.76	7.08	7.40	7.72	8.04	8.37	8.69	9.01	9.33	9.65	9.97	10.28			
650	3.68	4.02	4.35	4.69	5.02	5.36	5.69	6.03	6.36	6.70	7.03	7.37	7.70	8.04	8.37	8.71	9.04	9.38	9.71	10.05	10.38	10.71			
700	3.82	4.17	4.52	4.87	5.21	5.56	5.91	6.26	6.60	6.95	7.30	7.65	7.99	8.34	8.69	9.04	9.38	9.73	10.08	10.43	10.77	11.11			
750	3.96	4.32	4.68	5.04	5.40	5.76	6.12	6.47	6.83	7.19	7.55	7.91	8.27	8.63	8.99	9.35	9.71	10.07	10.43	10.79	11.15	11.51			
800	4.09	4.46	4.83	5.20	5.57	5.94	6.32	6.69	7.06	7.43	7.80	8.17	8.54	8.92	9.29	9.66	10.03	10.40	10.77	11.15	11.52	11.89			
850	4.21	4.60	4.98	5.36	5.74	6.13	6.51	6.89	7.28	7.66	8.04	8.42	8.81	9.19	9.57	9.96	10.34	10.72	11.11	11.49	11.87	12.25			
900	4.33	4.73	5.12	5.52	5.91	6.30	6.70	7.09	7.49	7.88	8.28	8.67	9.06	9.46	9.85	10.25	10.64	11.03	11.43	11.82	12.22	12.61			
950	4.45	4.86	5.26	5.67	6.07	6.48	6.88	7.29	7.69	8.10	8.50	8.91	9.31	9.72	10.12	10.53	10.93	11.34	11.74	12.15	12.55	12.95			
1000	4.57	4.98	5.40	5.82	6.23	6.65	7.06	7.48	7.89	8.31	8.72	9.14	9.55	9.97	10.38	10.80	11.22	11.63	12.05	12.46	12.88	13.29			
1050	4.68	5.11	5.53	5.96	6.38	6.81	7.24	7.66	8.09	8.51	8.94	9.36	9.79	10.22	10.64	11.07	11.49	11.92	12.34	12.77	13.19	13.61			
1100	4.79	5.23	5.66	6.10	6.53	6.97	7.41	7.84	8.28	8.71	9.15	9.58	10.02	10.46	10.89	11.33	11.76	12.20	12.63	13.07	13.50	13.93			
1150	4.90	5.35	5.79	6.24	6.68	7.13	7.57	8.02	8.46	8.91	9.35	9.80	10.25	10.69	11.14	11.58	12.03	12.47	12.92	13.36	13.81	14.25			
1200	5.01	5.46	5.92	6.37	6.83	7.28	7.74	8.19	8.65	9.10	9.56	10.01	10.47	10.92	11.38	11.83	12.29	12.74	13.20	13.65	14.11	14.56			

NOTES:

- (1) See Section 2.13.4.2.1 of ASME A17.1 Safety Code for Elevators for details
- (2) See Section 2.13.4.2.2 of ASME A17.1 Safety Code for Elevators for details

Kinetic Energy Formula

$$\frac{1}{2} \left(\frac{M}{32.2} \right) (V)^2 = 2.5 \text{ ft-lbf}$$

M = Combined Weight of Car and Hoistway Doors and All Attached Equipment

V = Speed in Feet Per Second

Troubleshooting

This section is divided into two topics:

- **Helpful Hints:** Real world information about door operator functions that can help with adjustment, repair, or troubleshooting.
- **Functional Troubleshooting:** Specific information to help the installer overcome most common problems encountered during SmarTraq installation.

Helpful Hints

Helpful Hints describes:

- Door Open and Door Close Logic
- Self-Holding
- Door Close Limit and Door Open Limit
- [Limit #1 and Limit #2](#)
- [Car Door Bumpers](#)
- [Belt and Chain Tension](#)
- [Motor Terminal Designation](#)
- [Learn Operation](#)
- [Stall Protection](#)
- [Door Open and Door Close Protection Timers](#)
- [Temporary Operation for Evaluation](#)
- [Encoder Cable](#)
- [Auto Reset](#)
- [Control Priority](#)
- [Control Status](#)

Door Open and Door Close Logic

SmarTraq is designed to allow power to be applied indefinitely to hold doors open or closed. With some controller designs, Otis comes to mind, a single relay or single family of relays is energized to open doors and then that same relay or relays are de-energized to close doors.

Self-Holding

Hold open torque parameter “Co” is used to hold doors open and hold close torque parameter “Cc” is used to hold doors closed. This feature is especially useful if doors tend to drift partially closed, when open command is removed, when fully open or drift partially open when fully closed, when close command is removed. Using the Co and Cc parameters, SmarTraq is self-holding in full open or full close positions. (If doors drift closed when **controller** power is removed, then some sort of door hold open device may be required.)

Door Close Limit and Door Open Limit

DCL and DOL are generated electronically when doors reach full close or full open position, up against the bumpers, and current increases. After an unobstructed “learn operation”, SmarTraq knows the difference between an obstruction and full open or full close position. DCL and DOL can only be generated within approximately the last 1/2-inch (13mm) of travel.

DOL and DCL have loss of power memory. When power is restored after a power loss, DCL will be re-established if doors were fully closed or DOL will be re-established if doors were fully open prior to power interruption.

Limit #1 and Limit #2

Limit #1 and Limit #2 are outputs from SmarTraq to the elevator controller. Either or both may be used to provide a variety of features including:

- Bypass retiring cam contact for controllers that use a retiring cam contact paralleled with a door position contact in door open logic
- Limited door reversal
- Advance start

The Limit 2 output may be programmed to activate anywhere between the full close and full open position. The Limit 1 output may only be programmed to activate between 50% closed and full closed. Each limit relay is provided with a form “C” contact that can be wired in a Normal Open or Normal Closed configuration. Both Limits have loss-of-power memory of On or Off status. Position memory is restored with the first full open door operation after power is restored.

Limit #1 is adjusted using the “LP” parameter.

Limit #2 is adjusted using the “LC” parameter.



Caution

Limit #1 and Limit #2 must NOT be used to remove the door open and door close signal to SmarTraq. Doors must reach full open position and generate DOL electronically before removing the door open signal to the drive. Doors must reach full close position and generate DCL electronically before removing the door close signal to the drive.

Car Door Bumpers

All door operators must have both open and close bumpers. For proper operation, it is very important that car door bumpers are in good shape and securely mounted. Doors must stop on the open door bumper at full open position and on the close door bumper in full closed position. It is also very important that car doors stop on car door bumpers at every floor. Make sure hoistway door bumpers, if provided, do not stop car doors before car door bumpers.

Belt and Chain Tension

Belts and chains must be tensioned properly, much tighter than normally expected. Belts must be in good shape. If after tension adjustment at proper torque, belts still slip, they must be replaced. Secondary drive V-belts on MAC and Dover Door Operators tend to slip, this is why GAL and ECI use a chain as part of their design. The belt type should be changed from a simple, V-belt to a more robust grip type V-belt with notches and additional traction provided on the sides of the belt. With closed-loop control, power transmission from the motor/encoder to doors must have minimum elasticity, slack, and slippage.

Motor Terminal Designation

The motor has six terminals, but only four are used. Looking down at the motor from above with the shaft facing you: Starting on the left side closest to the shaft, the first terminal is “W”, then “V” in the middle, and “U” toward the encoder end. The middle terminal on the right side is “N.”

Learn Operation

The “learn operation” can only take place if the drive thinks the doors are fully closed (indicated when “Lr” is displayed and the DCL LED is lighted). Hold Open/Close switch in close direction until “Lr” is displayed and the DCL LED is lighted. Reduce “C1” parameter if torque is too high in open direction. See table and adjust closing torque parameters if torque is too high in close direction.

Stall Protection

SmarTraq has built-in stall protection in both directions of travel. In the open direction, an internal stall timer is set for approximately one minute. If the door open signal to the drive is activated for more than one minute, the drive will automatically shut off. The drive will not respond until the signal is removed and reapplied or the opposite direction signal is applied. The stall timer for the close direction operates in a similar manner, but is set for approximately two minutes.

Door Open and Door Close Protection Timers

Door open and door close protection timers must be set longer than it takes the doors to open or close at the lowest speeds (first open operation after restoring power and nudging close). Door open and close protection timers are set at the elevator Controller.

Temporary Operation for Evaluation

Temporary operation for evaluation can be accomplished easily by removing the existing motor and setting it aside without removing the wires. Rest the drive on the car top. Install the new motor and wire the motor and encoder to the drive. Wire the drive to a power cord with a plug. **(Be certain that the outlet is providing the correct 120, 208, or 240VAC operating power and that the inverter drive input wiring has been properly set for that voltage.)** Plug the power cord into the car top electrical outlet. Turn on power and adjust the door operator. Once you’re satisfied that everything is OK, either return the door operator to its original condition or remove the old motor and temporary wiring, mount the drive, wire the new motor and encoder to the drive and wire the drive to the controller.

Note 

MCE does NOT recommend permanently wiring the drive to the car lighting power circuit.

Encoder Cable

The encoder cable is approximately eight feet (2.5 m) long with six (6) pre-stripped wires and a small piece of shrink tubing on one end. The wires are; black, white, red, green, blue and yellow/green. The other end of the cable is connected internally to the motor. We recommend that the cable be kept at its original length and the excess, if any, coiled up in the drive enclosure. However, if the cable length is reduced you will notice that there is no yellow/green wire, but there is a brown wire. The brown wire is not used and the yellow/green wire is actually a short piece of wire attached to the shield.

Auto Reset

If power is lost, then rapidly re-applied, the drive may fault. If so, the drive will auto-reset within three (3) seconds. The drive will accommodate up to four (4) faults within a one-hundred (100) second period of time. Should a fifth fault occur before the 100-second timer has expired, it will be necessary to shut off power to the drive, wait several seconds, then re-apply power. After an auto-reset, the drive operates in the same manner as when power is first applied — the motor will cog to synchronize and the doors will open at slow speed until DOL is established. Refer to the Troubleshooting section should a continuous drive fault occur.

Control Signal Status

The Isolation Board, located just below the Programmer Board, has LEDs that indicate active control status. (The associated LED lights when its control input is active.) There are five input control signal possibilities:

- Heavy Door
- Auxiliary
- Nudging
- Door Close
- Door Open

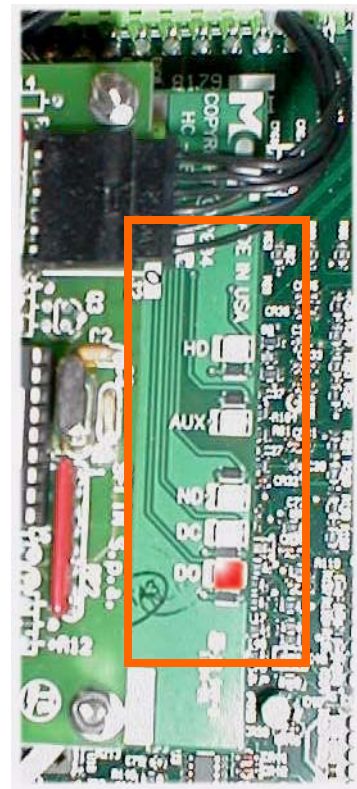

Functional Troubleshooting

Troubleshooting examples are provided in “installation order” specifically to help the installer through the process. The “top twelve” technical support issues are also listed and referenced below. (If you are looking at this on-line (in a pdf file), just click on a top twelve topic to jump to that spot in the guide. If there are multiple entries, just click on the page number.

- Closing torque too high: [Please refer to “Torque Adjustment” on page 35.](#)
- Closing torque too low: [Please refer to “Torque Adjustment” on page 35.](#)
- Opening torque too high: [Please refer to “Torque Adjustment” on page 35.](#)
- Opening torque too low: [Please refer to “Torque Adjustment” on page 35.](#)
- No DCL: Refer to [page 13](#), [page 24](#), [page 29](#), and [page 31](#).
- No DOL: Refer to [page 14](#), [page 24](#), [page 32](#).
- Cannot learn: Refer to [page 13](#), [page 30](#).
- Cannot change parameters: Refer to [page 18](#), [page 30](#).
- Doors drift close: Refer to [page 24](#).
- Doors drift open: Refer to [page 24](#).
- Cut encoder cable, no yellow/green wire: Refer to [page 27](#).
- Car door bumpers: Refer to [page 25](#).

Power Up

When power is applied to the SmarTraq Drive, the GREEN LED (DL1-U) on the main board will light. The RED LED (DL2-R) on the main board should remain OFF. The Programmer board should display a SINGLE BAR and the REMOTE or LOCAL led will be ON.

IF... Programmer display and Remote or Local LEDs are off and green LED on main board is on:

1. Check connections between main board and programmer board.
2. Verify connectors are inserted correctly.

IF... Programmer display and Remote or Local LEDs are off and green LED on main board is off:

1. Confirm correct AC voltage provided to terminals.
2. Check all connections between AC voltage supply from controller to transformer in the drive.
3. Confirm main line disconnect switch is ON.
4. Confirm all fast connectors inside drive are inserted correctly.
5. Confirm that no pieces of conductive material dropped onto boards.
6. Check fuses in drive.

IF... The red LED on main board is on:

1. Confirm input voltage matches drive, line input configuration. [Please refer to “SmarTraq Wiring Diagram” on page 6.](#)
2. Confirm that no pieces of conductive material dropped onto boards.
3. Confirm all fast connectors inside drive are inserted correctly.

Motor Synchronization

If power up is successful, the door operator is ready to synchronize the motor.

1. Select LOCAL on the programming board.
2. Press Open/Close switch to provide a momentary OPEN or CLOSE command.

The motor will cog to synchronize the rotor. Time required for this operation varies, but should be less than 2 seconds. When synchronization is complete, the door operator is ready to accept commands.

IF... Motor does not cog and synchronize:

1. Confirm motor wires are connected correctly to main board at connector TB-2.
2. Confirm encoder wires are connected correctly to main board at connector TB-3.
3. Confirm programmer to main board connections (TB-9/J2 and TB-8/J1) are OK.

IF... Motor cogs indefinitely, drive shuts down (after two minutes), and red LED is ON:

1. Confirm ENCODER WIRES are connected correctly to main board at connector TB-3, especially green wire on terminal 9.
2. Open rear cover of motor and check all connectors to make sure they are inserted correctly.

First Door Closing

If motor synchronization was successful, the next step is to CLOSE the doors. This is because programming board parameters can only be accessed after the drive detects FULL DOOR CLOSE and the DCL signal is ACTIVE. Even though doors were closed by hand, IT IS ALWAYS NECESSARY to give a close command until DCL is activated. When the first full door close position is detected and DCL is generated, "Lr" will be displayed on the programmer board. Parameters can now be accessed.

IF... Motor does not rotate properly, makes noise, or vibrates:

1. Confirm encoder wires are connected correctly to main board at connector TB-3.
2. Open rear cover of motor and check that all connectors are inserted correctly.
3. Confirm that the shielded wire of the encoder cable does not touch any metal part of the enclosure or door operator.
4. If previous steps are OK, cycle power and repeat procedure.

IF... On the close command, doors move in open direction, brake, and drive resets:

1. Problems in start-up procedure were encountered and the drive reset. Procedure must be repeated starting with Motor Synchronization.
2. If problems persist, cycle power and repeat entire procedure.

IF... Doors reach close position but the DCL signal is not generated, there is probably slippage somewhere in the mechanical transmission system and the motor is still turning while the doors are stopped:

1. Check belt tension. Tighten as necessary to prevent slippage. Grip-notch type belts may be required.

2. If tightening the belt is not effective, stop the motor by hand (minimal amount of pressure is usually required) so that DCL is generated. Set lower values for door closing torque parameters (reduces full close torque to reduce slippage).

IF... DCL is generated but Pr is not displayed:

1. Check connections between main board and programmer board.

Learn Process

If the first closing of the doors was completed correctly and DCL is active, the learning process can be executed:

1. With “Lr” displayed, press ENTER.

Doors should reach full open position, then reverse and reach full close position. During this process, it is important that doors open to their maximum width and close completely (including additional movement the motor may make when doors are fully closed).

Completing the learn process is required for proper operation.

IF... You press ENTER and learning does not begin:

1. More than likely, DCL was not generated. Give close command again until DCL is generated.

IF... During opening, doors stop and reverse before reaching full open, the “C1” parameter may be set too low or there is too much friction:

1. Ensure that doors move freely.
2. If possible, access programmer board and change value of parameter “C1” (DCL must be generated) and repeat learning process.
3. If it is not possible to access the programmer board and change parameter “C1” because DCL was not generated, cycle power and repeat procedure beginning with learn process.
4. Change the value of “C1” and repeat learning process.

IF... During opening, doors reach full open and push up against bumper but do not reverse, there is probably slippage somewhere in the mechanical transmission system and the motor is still turning while doors are stopped:

1. If possible, stop motor by hand. Doors should now reverse and close. If not, turn off power and attempt to open doors again.
2. Check the mechanical transmission system, tighten belts.
3. Repeat start up procedure. If problem persists, cycle power and repeat procedure beginning with first closing of the doors. After this, reduce value of “C1” and “Co” and execute learning process.
4. Repeat until correct values for “C1” and “Co” are found.

Note

Multiple parameters affect closing torque. [Please refer to “Inverter Drive Parameters” on page 16.](#)

IF... During opening, doors reach full open, push up against bumper, and stop with red LED (DL2-R) on, a fault condition occurred (most likely due to low AC input voltage):

1. Check AC voltage using a voltmeter. Check voltage continuously during opening, especially when doors push up against full open bumper. Voltage should not drop by more than 5% of nominal value (120/208/240VAC).

If voltage drop is excessive, and drive locks up, cycling power is required.

2. Excessive voltage drop may be due to a poor connection between source and drive. Wires may be undersized. Transformer in controller may be underrated.
3. As an experiment, temporarily use an alternate power source such as car lighting supply or a building convenience outlet circuit and repeat learn process. If problem is resolved in this manner, a more robust power source from controller is required.

IF... During closing, doors reach full close, push up against bumper, and stop with red LED (DL2-R) ON, follow steps for the problem above.

IF... During closing, doors stop before reaching full close and DCL is generated, “C3” value may be too small or there is too much friction:

1. Ensure doors move freely without excessive friction.
2. If doors move freely, increase “C3” and repeat learn process.

IF... During closing, doors reach full close and push up against bumper but DCL is not generated, there is probably slippage somewhere in the mechanical transmission system and the motor is still turning while doors are stopped:

1. If possible, try to stop motor by hand (only a small amount of pressure is usually required). The drive should now generate DCL. If not, turn off power.
2. Check mechanical linkage and transmission system. Tighten belts.
3. Repeat start up procedure. If problem persists, cycle power and repeat procedure through first closing of doors. After this, reduce value of “C3” and execute learn process.
4. Repeat this step until correct value for “C3” is found.

Note

Multiple parameters affect closing torque. Please refer to [“Inverter Drive Parameters” on page 16](#).

First Open/Close After Cycling Power

After power is cycled, and doors are in full close position with DCL active, an OPEN command should be given using local command on programmer board. Doors will move in open direction at REDUCED SPEED. If a CLOSE command is given before DOL is generated, doors will move in close direction at REDUCED SPEED.

DOORS WILL MOVE AT REDUCED SPEED UNTIL FIRST DOL IS GENERATED.

This is necessary after having cycled power because the drive needs to determine a fixed reference point for door position. (While the drive was turned off, the doors could have moved.) BE SURE CONTROLLER DOOR OPEN PROTECTION TIMER HAS SUFFICIENT TIME TO ALLOW FOR FIRST SLOW OPENING WITHOUT TRIPPING (set at elevator Controller).

IF... After reaching full open, DOL is generated but doors close at reduced speed:

1. Check value of "U3" parameter. Increase if set too low.
2. Check that NUDGE speed was not inadvertently selected.
3. Check that HEAVY DOOR was not selected by controller.
4. Be sure learn process was performed correctly.

IF... After reaching full open, DOL is NOT generated and doors close at reduced speed, there is probably slippage somewhere in the mechanical transmission system and the motor is still turning when doors are stopped:

1. Tighten belts. Replace if worn. May need grip-notch type belts.
2. If problem persists, decrease "C1" and "Co" parameters.

IF... DOL is generated before doors reach full open and doors stop:

1. Check for excessive friction or an obstacle in path of doors.
2. If first step checks OK, increase "C1" parameter.

IF... After reaching full open, DOL is generated and doors close at correct speed but, when fully closed, DCL is not generated, there is probably slippage somewhere in the mechanical transmission system and the motor is still turning when doors are stopped:

1. Tighten belts. Replace if worn. May need grip-notch type belts.
2. Should problem persist, decrease "C3" parameter.
3. Should problem persist, repeat learn process.

IF... Red LED turns ON: [Please refer to "During opening, doors stop and reverse before reaching full open, the "C1" parameter may be set too low or there is too much friction: " on page 30.](#)

IF... Doors move in close direction but stop before reaching full close and DCL is not generated:

1. Check that there is no obstruction.
2. Check that torque is sufficient to overcome friction.
3. If everything appears to be OK, increase "C3".

Opening and Closing

Open and closing operations are accomplished by setting parameters for:

- High Speed Open and Close speeds using “U1/ U3”.
- Low Speed Open and Closing speeds using “U2/ U4”.
- Initial Open speed and distance using “U0” and “PL”.
- Open and Close acceleration using “A0/A2”.
- Open and Close deceleration and slowdown distance using “A1” and “P2/A3” and “P7”.

IF... Deceleration during opening or closing is too fast and doors jerk:

1. Parameter “A1” or “A3” is set too high. Reduce “A1” and “A3” and, consequently, reduce “P2” and “P7”.
2. Deceleration is too late and doors are approaching full open/close position too fast, safety braking action is activated, which suddenly reduces door speed. Reduce “P2” and “P7” and increase “A1” and “A3”.
3. These steps are usually sufficient to solve this problem. However, should problem persist and **YOU ARE SURE YOU** have tried all possible combinations of values for “A1”, “A3”, “P2”, and “P7”, change the value of the “Cb” parameter. Start with a value of 20, for example, and decrease gradually, checking each time until the problem is corrected.

“Cb” is a parameter which is usually kept at 00 value and is used to limit braking action of doors. We suggest it be used only if absolutely necessary and no other action is effective. Do not reduce value of “Cb” too much, otherwise there may not be enough braking action. It should be kept at the highest possible value that corrects the problem.

Setting “Cb” to 00 does not put a limit on braking torque.

IF... A high value for opening speed is set but doors move slower than expected:

1. Be sure DOL was detected.
2. Acceleration parameter “A0” may be set too low.
3. Doors may be very heavy or there is excessive friction or mechanical ratio between motor and doors is low so that torque or power limit has been reached.

IF... A high value for closing speed is set but doors move slower than expected:

1. Be sure DOL was detected.
2. Check that open acceleration parameter “A2” is not set too low.
3. Doors may be very heavy or there is excessive friction or mechanical gear ratio between motor and doors is low so that torque or power limit has been reached.
4. Value of “C3” parameter is too low, so that allowable closing torque is too low and not enough to move doors at desired speed. Increase value of “C3” gradually and check if this corrects problem.

Note

Multiple parameters affect closing torque. [Please refer to “Inverter Drive Parameters” on page 16.](#)

IF... Doors bump when opening or closing:

1. Slowdown points “P2” or “P7” are too near full open or close positions. Reduce “P2” or “P7”.
2. Deceleration values “A1” or “A3” are too low. Increase “A1” or “A3”.
3. Low speeds “U2” or “U4” are too high. Reduce “U2” or “U4”.
4. Opening and closing speeds “U1” or “U3” are too high and doors are heavy with low mechanical ratio so braking power required exceeds operator ratings.
5. “Cb” parameter is at a low value so braking action has been reduced too much.

IF... While opening or closing, especially during acceleration, doors stop and red LED turns ON:

1. Check AC input voltage. Be sure there is not excessive voltage drop, measured at terminals L1D and L2D, while opening or closing, especially during acceleration.

Note

Make certain that hoistway doors are engaged while checking for excessive voltage drop.

Reopening and Reclosing

Reopening and reclosing are accomplished by setting parameters “Po”, “Pc”, “Pr”, “Ar”, “Ab”. During reopening, the function of parameters “P2” and “A1” is substituted for by “Po” and “Ar”. During reclosing (Fire Phase II “peek-a-boo” operation), the function of parameter “P7” is substituted for by “Pc”. “Ab” regulates reversal braking.

Parameter “Pr” sets the transitional edge between “normal opening” and “reopening.” This parameter should be kept at 00 except in rare cases where mechanical ratio between motor and doors varies and dramatically changes speed.

IF... During reopening, doors bump, parameter “Po” is set too high and/or “Ar” is set too low.

1. Increase “Ar” and/or reduce “Po” until correct compromise is found.

IF... During reclosing, doors bump

1. Parameter “Pc” is set too high. Reduce “Pc”.

IF... During reopening, doors decelerate too rapidly, parameter “Po” is set too low and/or “Ar” is set too high.

1. Increase “Po” and/or reduce “Ar” until correct compromise is found.

IF... During reclosing, doors decelerate too rapidly, Parameter “Pc” is set too low:

1. Increase “Pc”

IF... During reopening or reclosing, deceleration point changes dramatically depending on position where reversal is commanded, parameter “Pr” has probably been set to a value other than 00 or has been set too high.

1. Reduce “Pr” until there are no inconsistencies. If not strictly necessary, set “Pr” at 00.

IF... During reopening, the doors take too long to fully reopen:

1. Increase “Pr” incrementally. Remember that the more “Pr” is increased, the more the possibility of inconsistency while approaching full open.

IF... During reversals, doors stop and reverse too rapidly, producing mechanical vibrations and bumps:

1. Reduce “Ab” until reversal is smooth.
2. Check mechanical system and correct as required.

IF... During reversals, it takes too long for doors to stop and reverse:

1. Increase “Ab” until reversal is smooth.

Torque Adjustment

Torque adjustment is accomplished by setting parameters “C1”, “C3”, “Co”, “Cc”, and “Cb”.

Note

After torque adjustments are made, learn process must be repeated. Multiple parameters affect closing torque. [Please refer to “Inverter Drive Parameters” on page 16.](#)

IF... In close direction, door close pressure is too high:

1. Reduce “C3” until door pressure is correct.

IF... In close direction, doors stop before reaching full close and DCL is NOT generated:

1. Check for an obstruction.
2. Check for friction in door system and, if necessary, increase “C3”.

IF... In close direction, DCL is generated slightly before doors are fully closed:

1. Make sure learn process was performed correctly.
2. “C3” may be set too low. Increase “C3”.

IF... In open direction, DOL is generated slightly before doors are fully open:

1. Make sure learn process was performed correctly.
2. “C1” may be set too low. Increase “C1”.

IF... After doors reach full open and DOL is generated, doors drift toward close direction:

1. If doors drift close, increase “Co”. The value of “Co” should be set to minimum necessary to keep doors from drifting close in order to minimize heating motor.

IF... After doors reach full close and DCL is generated, doors drift toward open position:

1. If doors drift open, increase “Cc”. The value of “Cc” should be set to minimum necessary to keep doors from drifting open in order to minimize heating motor.

Maintenance

On a regular basis, while checking other elevator components, we suggest the following maintenance for door operators.

Harmonic Operators

Check and adjust if needed:

- Motor V-belt: Mid-way between the pulleys, the belt should deflect 1/2-inch (13mm) under moderate pressure. The belt should not slip. Replace if cracked or worn.
- Open and close stop rollers: Check for flat spots. Rotate or replace as needed.
- Chain tension: Adjust tension roller to remove slack if needed.
- Urethane dampening strips: Check urethane strips around chain pulley and sprocket. Replace if broken. (These strips reduce operator noise.)
- Door linkage bearings: Oil or grease once a year.
- Clutch cable: Check tension. Adjust if undue slack.
- Door bumpers: Check for distortion or cracking. Replace if needed.
- Check that operator and motor mountings are tight and true.



Note

Do not lubricate the chain. Excess can drip down onto passengers.

Linear Operators

Check and adjust if needed:

- Motor cog belt: Check for minimal slack. Check that belt drive ridges are not rounded. Replace if cracked or worn.
- Door belt: Check tension; adjust if needed. Check that belt drive ridges are not rounded. Replace if cracked or worn.
- Clutch cable: Check tension. Adjust if undue slack.
- Door bumpers: Check for distortion or cracking. Replace if needed.
- Check that operator and motor mountings are tight and true.

Firmware Upgrades

Firmware (software and microchips) upgrades are sometimes shipped to the field. Each upgrade kit has a set of instructions but, if they are unavailable, generic upgrade instructions are also provided here. Upgrade kits may contain one or two microchips and (if needed) a special tool designed to safely remove the microprocessor chip from its socket:

- C_: 18-pin programmer chip
- S_: 44-pin microprocessor chip

The programmer chip replaces the existing programmer chip on the upper board in the Smart-Traq drive enclosure. The microprocessor chip replaces the existing chip on the lower board in the enclosure.

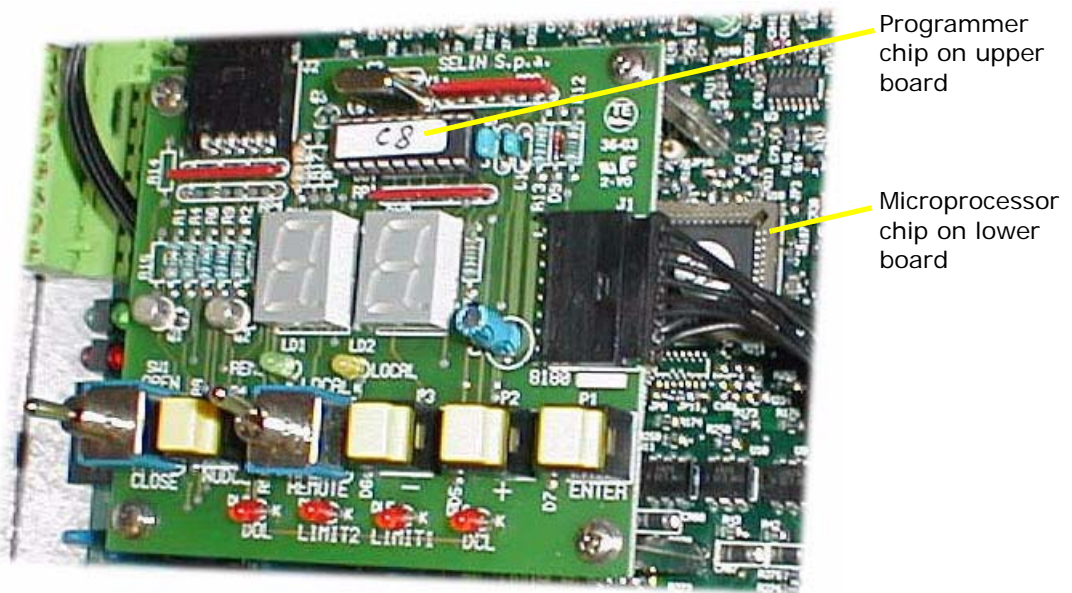

Caution

Static discharge will damage microchips — be certain you are grounded as you work.

Replacing Microchips

1. Make certain power to the SmarTraq inverter drive is shut off.
2. Remove the four screws securing the cover on the drive enclosure. Remove the cover. If the inverter drive is equipped with an ON/OFF switch, place it in the OFF position.
3. Remove the four screws securing the upper board to its stand-offs. Hold the stand-offs so that they do not unscrew from the lower board.
4. Using a small (preferably plastic) screwdriver, carefully lever the programmer chip out of its socket, raising first one end and then the other in stages to avoid damaging pins and socket.
5. Note that the chip must be correctly inserted in the socket with the notch at one end of the chip matched to the notch at one end of the socket. Insert the new chip gently, taking care not to bend the pins. Make certain the chip is completely seated in the socket.
6. Next, use the special tool included with this kit to carefully remove the microprocessor chip from its socket on the lower board. Be careful not to damage the socket or bend the pins on the chip.

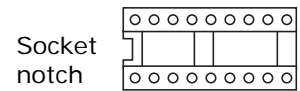
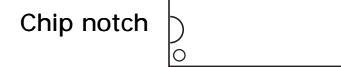
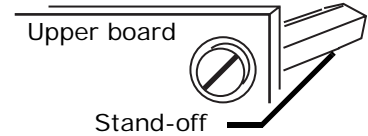

Correct insertion indicated by angled corner on socket and on chip

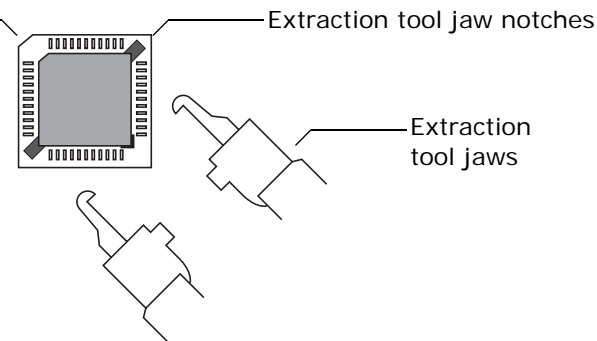

7. Note that the microprocessor must be correctly inserted in the socket with the angled corner of the chip aligned with the angled corner of the socket. Insert the new microprocessor chip using **EXTREME CARE** not to bend the pins. If a pin is bent, the IC must be replaced. It is very easy to break a pin, so be careful. Make certain the microprocessor chip is completely seated in the socket.
8. Reinstall the upper board on its stand-offs. Take care not to overtighten the screws.
9. If the inverter drive is equipped with an ON/OFF switch, place it in the ON position. Reinstall the cover on the drive enclosure.
10. Restore power to the inverter drive. Refer to earlier sections of this guide for operating and adjusting instructions.

Board Set Replacement

DO NOT remove or attempt to repair individual boards! If necessary, the entire board set is replaced as a single unit. The circuit board set is designed for easy field replacement:

1. Remove the cover from the drive enclosure. Power down the unit.
2. Unplug signal wire connections to board set. Locations A, B, and C.
3. Disconnect power and ground connections to board set. Locations D, E, and F.

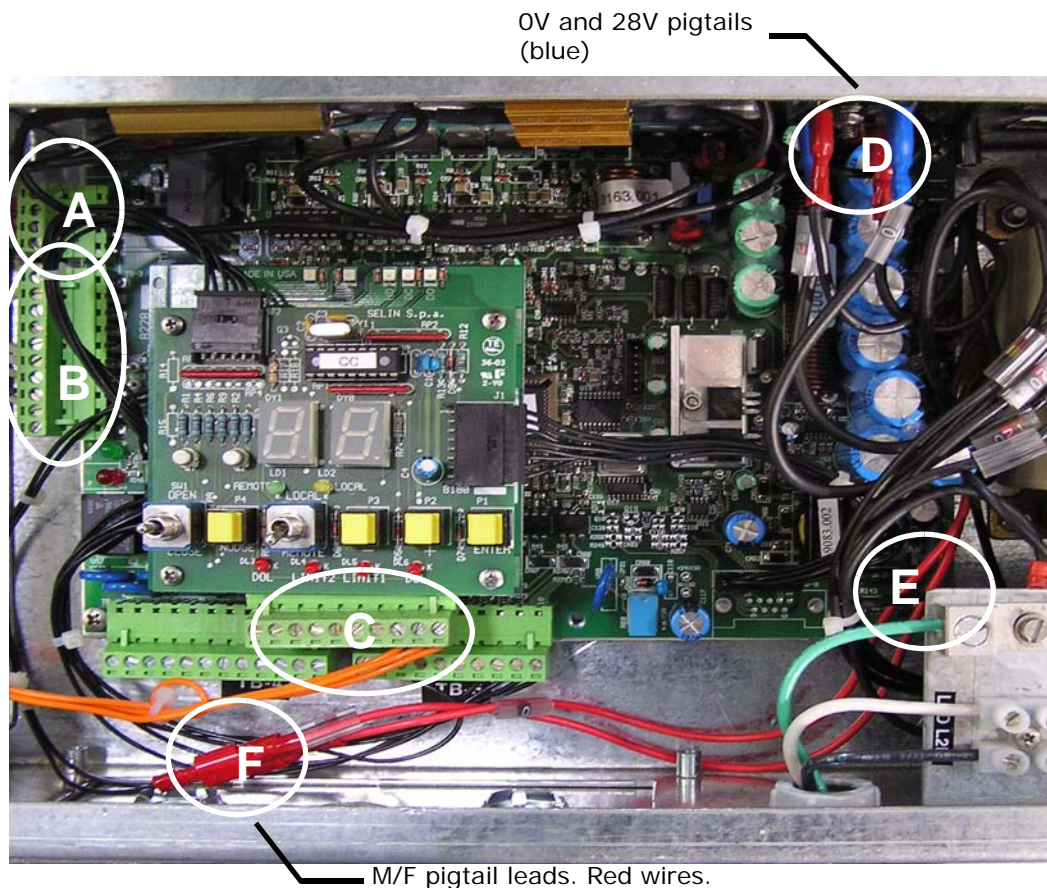

4. Remove the four screws securing the board set cover plate in place. (The screws have a yellow dot adjacent to them.) Slide the board set out.



Remove four retaining screws.
Slide board set out.

Replacement board set:
HC-DO-DRIVE-MODULE

5. Install the new board set. Reconnect wiring.
6. Power up. Perform door learn process and adjust parameters as needed.

